

REVISIONS			
REV.	DESCRIPTION	DATE	APPROVED
REL-01		10/6/2008	

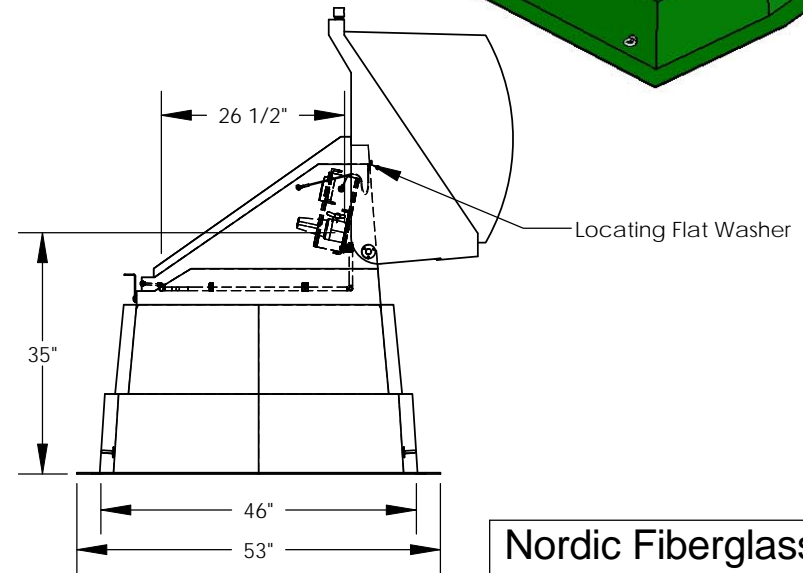
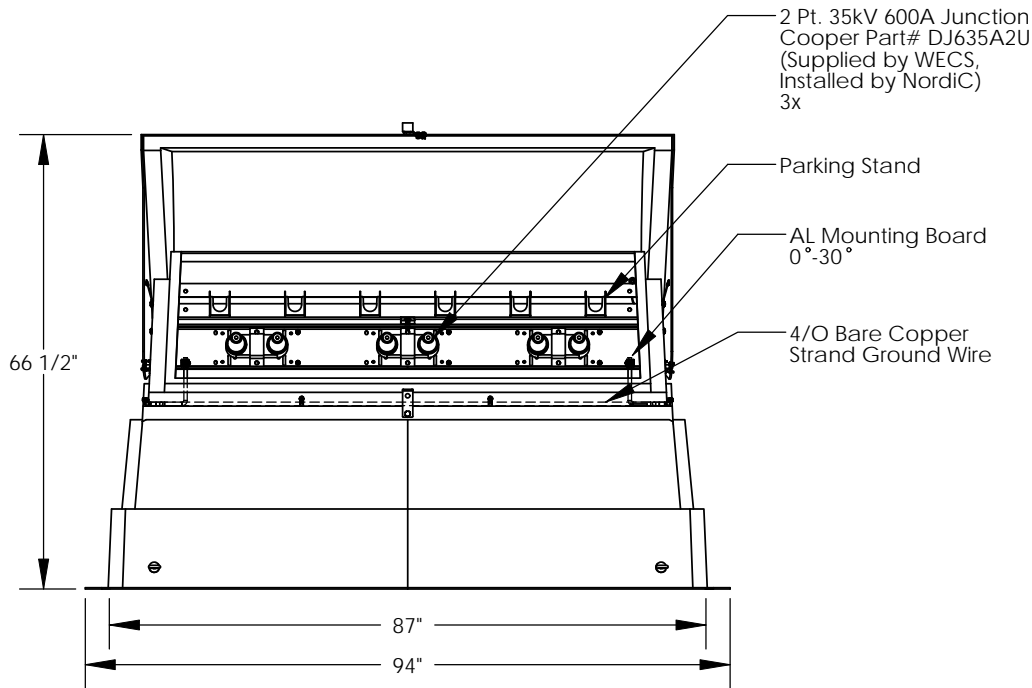
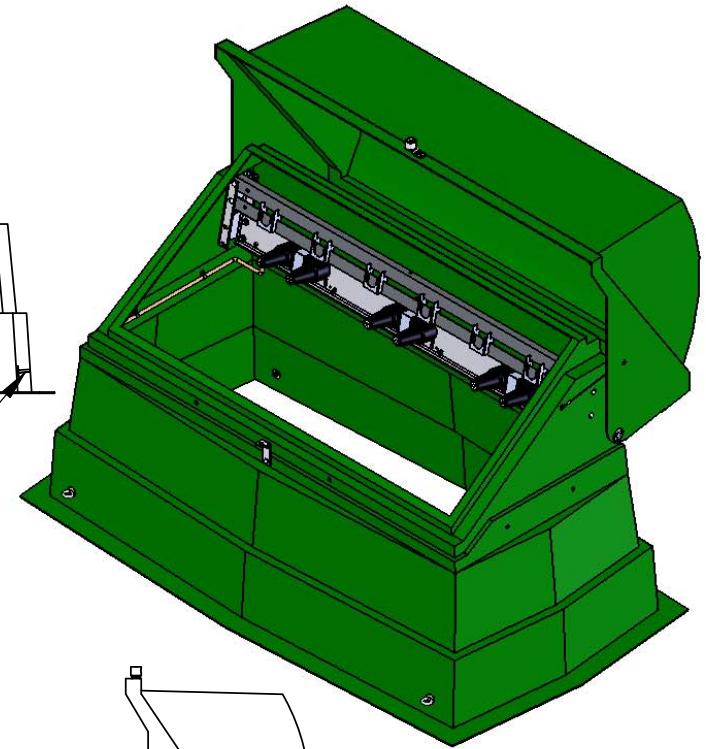
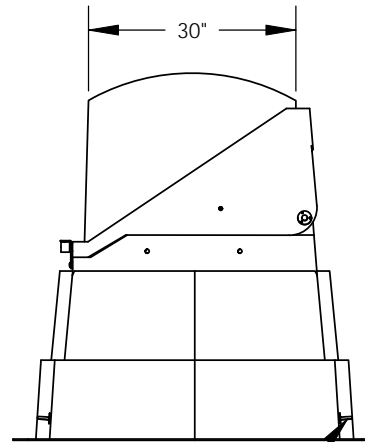
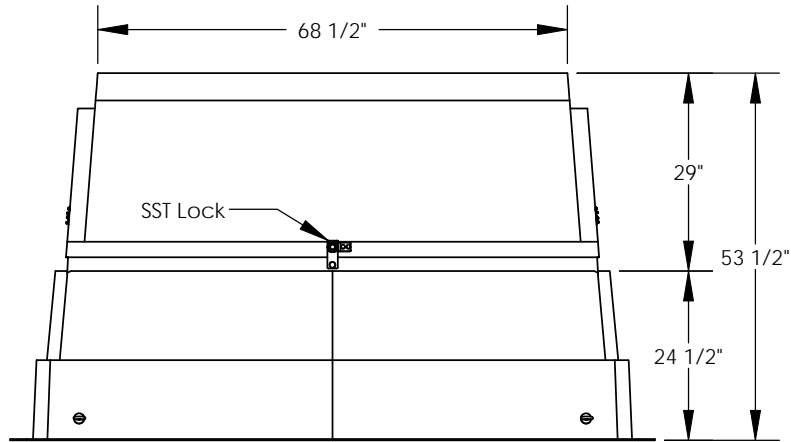

Nordic Fiberglass, Inc.

21415 US Hwy 75 NW, Warren, MN 56762
 www.nordicfiberglass.com
 218-745-5095 ph. --- 218-745-4990 fax

ND-683054-MG-PA71-23566-W3E

PROPRIETARY AND CONFIDENTIAL
 THE INFORMATION CONTAINED IN THIS DRAWING IS THE SOLE PROPERTY OF NORDIC FIBERGLASS, INC. ANY REPRODUCTION IN PART OR AS A WHOLE WITHOUT THE WRITTEN PERMISSION OF NORDIC FIBERGLASS, INC. IS PROHIBITED.

Customer Name: N/A		
DIMENSIONS ARE IN INCHES TOLERANCES: ANGLES ± 1° FRACTIONAL ± 1/2 ONE PLACE DECIMAL ±.060 TWO PLACE DECIMAL ±.030 THREE PLACE DECIMAL ±.015		
MATERIAL		
DRAWN	R.L.J.	09/23/08
CHECKED	---	--/--/--

SIZE	ITEM ID:	REV.
A	04062.53	REL-01
SCALE:1:28	SHEET 1 OF 1	